

SOL / LEFT / ЛЕВАЯ

SAĞ / RIGHT / ПРАВАЯ

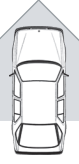

Duster

04/2010->

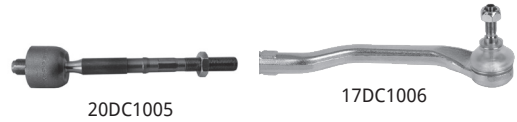

DACIA

As Metal Ref. Код As Metal	Açıklama Description / Разъяснение		Orijinal Kod Original Number / Оригинальный Код
10DC1005	Rotil Ball Joint Шаровая опора	Alt Lower Нижняя	40 16 023 08R
17DC1005	Rotbaşı Tie Rod End Наконечник рулевой тяги	M14x1,5 Sağ Diş M14x1,5 RHT M14x1,5 Правая Резьба	82 01 108 339
17DC1006	Rotbaşı Tie Rod End Наконечник рулевой тяги	M14x1,5 Sağ Diş M14x1,5 RHT M14x1,5 Правая Резьба	82 01 108 332
20DC1005	Rotmili Axial Joint Тяга рулевая	M14x1,5 Sağ Diş M14x1,5 RHT M14x1,5 Правая резьба	8201 108 350
26RN0515	Viraj "Z" Rotu Link Stabilizer Тяга стабилизатора	Arka Rear Задняя	82 00 814 411 54 61 800 01R 54 61 895 01R
38DC1005	Aks Burcu Axle Bushing САЙЛЕНТБЛОК БАЛКИ	- - -	60 01 549 988 60 01 549 989 82 00 287 912
38DC1015	Salıncak Burcu Wishbone Bushing Сайлентблок рычага	- - -	5450 065 42R 5450 167 46R

SOL / LEFT / ЛЕВАЯ

SAĞ / RIGHT / ПРАВАЯ

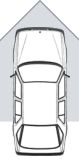

LOGAN

09/2004->

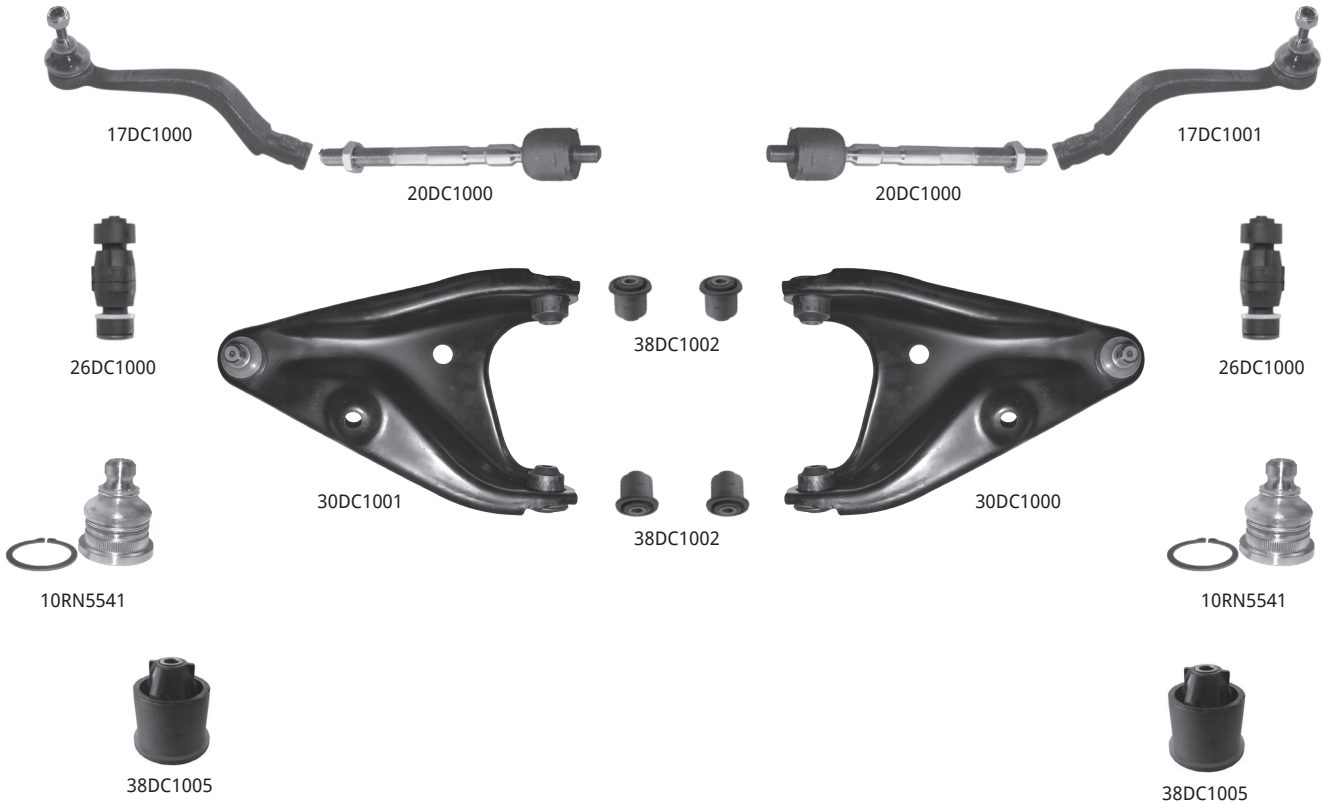

As Metal Ref. Код As Metal	Açıklama Description / Разъяснение	Orijinal Kod Original Number / Оригинальный Код
10RN5541	Rotil Ball Joint Шаровая опора	Alt (18mm) - Segmanlı Lower (18mm) - with ring Нижняя (18mm)
17DC1000	Rotbaşı Tie Rod End Наконечник рулевой тяги	M14x1,5 Sağ Diş M14x1,5 RHT M14x1,5 Правая Резьба
17DC1001	Rotbaşı Tie Rod End Наконечник рулевой тяги	M14x1,5 Sağ Diş M14x1,5 RHT M14x1,5 Правая Резьба
20DC1000	Rotmili Axial Joint Тяга рулевая	M14x1,5 Sağ Diş M14x1,5 RHT M14x1,5 Правая Резьба
26DC1000	Askı Rotu Thrust Rod Тяга стабилизатора	Ön Front Передняя
30DC1000	Salıncak Wishbone Рычаг	Alt Lower Нижний
30DC1001	Salıncak Wishbone Рычаг	Alt Lower Нижний
38DC1002	Salıncak Burcu Wishbone Bushing Сайлентблок рычага	Alt Lower Нижний
38DC1005	Aks Burcu Axle Bushing Сайлентблок Балки	- - -

Asmetal products fit to mentioned trademarks and OE numbers in this catalogue.

SOL / LEFT / ЛЕВАЯ

SAĞ / RIGHT / ПРАВАЯ

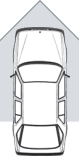

LOGAN II 2012---
LODGY 2012---
DOKKER 2012---



20DC2000



20DC2000



As Metal Ref.
Код As Metal

Açıklama
Description / Разъяснение

Orijinal Kod
Original Number / Оригинальный Код

20DC2000

Rotmili
Axial Joint
Тяга рулевая

M14x1,5 Sağ Diş
M14x1,5 RHT
M14x1,5 Правая Резьба

48 52 131 72 R
48 52 111 05 R

SOL / LEFT / ЛЕВАЯ

SAĞ / RIGHT / ПРАВАЯ

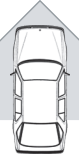

Sandero 06/2008->



17DC1000



20DC1000



20DC1000

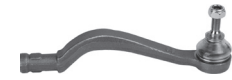

17DC1001



26DC1000



10RN5542



10RN5542



26DC1000



38DC1005



38DC1005

As Metal Ref.
Код As Metal

Açıklama
Description / Разъяснение

Orijinal Kod
Original Number / Оригинальный Код

10RN5542

Rotil
Ball Joint
Шаровая опора

Alt (18mm)
Lower (18mm)
Нижняя (18mm)

6001 547 519/520
8200 216 376/377
8200 298 454/455
For Wishbones

17DC1000

Rotbaşı
Tie Rod End
Наконечник рулевой тяги

M14x1,5 Sağ Diş
M14x1,5 RHT
M14x1,5 Правая Резьба

60 01 547 610
60 01 550 442

17DC1001

Rotbaşı
Tie Rod End
Наконечник рулевой тяги

M14x1,5 Sağ Diş
M14x1,5 RHT
M14x1,5 Правая Резьба

60 01 547 611
60 01 550 443

20DC1000

Rotmili
Axial Joint
Тяга рулевая

M14x1,5 Sağ Diş
M14x1,5 RHT
M14x1,5 Правая Резьба

60 01 547 606
60 01 550 441

26DC1000

Askı Rotu
Thrust Rod
Тяга стабилизатора

Ön
Front
Передняя

60 01 547 138
82 00 277 960

38DC1005

Aks Burcu
Axle Bushing
Сайлентблок Балки

-
-
-

60 01 549 988 / 60 01 549 989
82 00 287 912

SOL / LEFT / ЛЕВАЯ

SAĞ / RIGHT / ПРАВАЯ

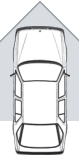

Sandero

06/2008->



17DC1000

20DC1000

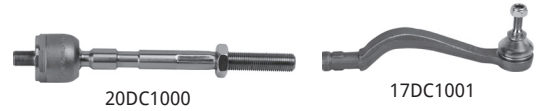

20DC1000

17DC1001



26DC1000



10RN5542



38DC1005



10RN5542



26DC1000



38DC1005

As Metal Ref.

Код As Metal

Açıklama

Description / Разъяснение

Original Kod

Original Number / Оригинальный Код

10RN5542	Rotil Ball Joint Шаровая опора	Alt (18mm) Lower (18mm) Нижняя (18mm)	6001 547 519/520 8200 216 376/377 8200 298 454/455 For Wishbones
17DC1000	Rotbaşı Tie Rod End Наконечник рулевой тяги	M14x1,5 Sağ Diş M14x1,5 RHT M14x1,5 Правая Резьба	60 01 547 610 60 01 550 442
17DC1001	Rotbaşı Tie Rod End Наконечник рулевой тяги	M14x1,5 Sağ Diş M14x1,5 RHT M14x1,5 Правая Резьба	60 01 547 611 60 01 550 443
20DC1000	Rotmili Axial Joint Тяга рулевая	M14x1,5 Sağ Diş M14x1,5 RHT M14x1,5 Правая Резьба	60 01 547 606 60 01 550 441
26DC1000	Askı Rotu Thrust Rod Тяга стабилизатора	Ön Front Передняя	60 01 547 138 82 00 277 960
38DC1005	Aks Burcu Axle Bushing Сайлентблок Балки	- - -	60 01 549 988 / 60 01 549 989 82 00 287 912

SOL / LEFT / ЛЕВАЯ

SAĞ / RIGHT / ПРАВАЯ

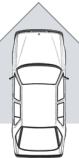

Special Products



17DC0500

20DC0500



20DC0500

17DC0500

As Metal Ref.

Код As Metal

Açıklama

Description / Разъяснение

Original Kod

Original Number / Оригинальный Код

17DC0500	Rotbaşı Tie Rod End Наконечник рулевой тяги	M12x1,25 Sağ Diş M12x1,25 RHT M12x1,25 Правая Резьба	-
20DC0500	Rotmili Axial Joint Тяга рулевая	M12x1,25 Sağ Diş M12x1,25 RHT M12x1,25 Правая Резьба	-

Asmetal products fit to mentioned trademarks and OE numbers in this catalogue.