

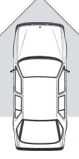

SOL / LEFT / ЛЕВАЯ

SAĞ / RIGHT / ПРАВАЯ

**Cielo** 02/1995->08/1997



170P4039



100P9120

**Leganza** 06/1997->12/2002



100P9120



170P4038

As Metal Ref. Код As Metal	Açıklama Description / Разъяснение		Orijinal Kod Original Number / Оригинальный Код
100P9120	<b>Rotil</b> Ball Joint Шаровая опора	<b>Alt</b> Lower Нижняя	<b>Cielo İçin</b> For Cielo Для Cielo
170P4038	<b>Rotbaşı</b> Tie Rod End Наконечник рулевой тяги	<b>M16x1,5 Sol Diş</b> M16x1,5 LHT M16x1,5 Левая резьба	1603 120 / 1603 164 / 04 788 122 901 40 407 / 902 72 683 / 903 75 505 947 88 122
170P4039	<b>Rotbaşı</b> Tie Rod End Наконечник рулевой тяги	<b>M16x1,5 Sağ Diş</b> M16x1,5 RHT M16x1,5 Правая резьба	324 038 / 784 6485 260 01 806 / 901 40 006 962 75 019
			324 039 / 784 6495 260 01 807 / 901 40 007 962 75 018

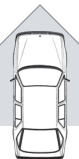
SOL / LEFT / ЛЕВАЯ

SAĞ / RIGHT / ПРАВАЯ

**Espero** 10/1991->09/1999



170P4039



170P4042



100P9120

**Lanos** 05/1997->



200P2000



200P2001

**Nexia** 02/1995->08/1997



170P4038



170P4042



100P9120

As Metal Ref. Код As Metal	Açıklama Description / Разъяснение		Orijinal Kod Original Number / Оригинальный Код
100P9120	<b>Rotil</b> Ball Joint Шаровая опора	<b>Alt</b> Lower Нижняя	1603 120 / 1603 164 / 04 788 122 / 901 40 407 902 72 683 / 903 75 505 / 947 88 122
170P4038	<b>Rotbaşı</b> Tie Rod End Наконечник рулевой тяги	<b>M16x1,5 Sol Diş</b> M16x1,5 LHT M16x1,5 Левая резьба	324 038 / 784 6485 260 01 806 / 901 40 006 962 75 019
170P4039	<b>Rotbaşı</b> Tie Rod End Наконечник рулевой тяги	<b>M16x1,5 Sağ Diş</b> M16x1,5 RHT M16x1,5 Правая Резьба	324 039 / 784 6495 260 01 807 / 901 40 007 962 75 018
170P4042	<b>Rotbaşı</b> Tie Rod End Наконечник рулевой тяги	<b>M12x1,5 Sağ Diş</b> M12x1,5 RHT M12x1,5 Правая резьба	<b>LANOS İçin</b> For LANOS Для LANOS
200P2000	<b>Rotmili</b> Axial Joint Тяга рулевая	<b>M12x1,5 Sağ Diş, Mekanik Direksiyon (25 Küre) LANOS İÇİN</b> M12x1,5 RHT, Manual Steering (25 Ball) For LANOS M12x1,5 Правая резьба, Механический Руль (25 Шар) Для LANOS	322 155 / 1603 453 931 92 445 / 260 30 411
200P2001	<b>Rotmili</b> Axial Joint Тяга рулевая	<b>M12x1,5 Sağ Diş, Mekanik Direksiyon (22 Küre) LANOS İÇİN</b> M12x1,5 RHT, Manual Steering (22 Ball) For LANOS M12x1,5 Правая резьба, Механический Руль (22 Шар) Для LANOS	322 155 / 1603 453 931 92 445 / 260 30 411

SOL / LEFT / ЛЕВАЯ

SAĞ / RIGHT / ПРАВАЯ

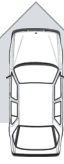

**Kalos**

09/2002->



17DW1000



20DW1000



20DW1000



17DW1001

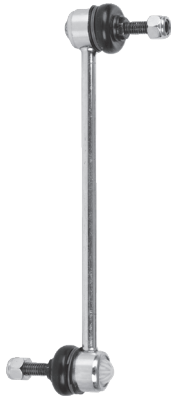

26DW2005



26DW2005



10DW1000



10DW1000

**As Metal Ref.**  
Код As Metal

**Açıklama**  
Description / Разъяснение

**Orijinal Kod**  
Original Number / Оригинальный Код

As Metal Ref. Код As Metal	Açıklama Description / Разъяснение	Orijinal Kod Original Number / Оригинальный Код
10DW1000	<b>Rotil</b> Ball Joint Шаровая опора	<b>Alt</b> Lower Нижняя 965 35 089
17DW1000	<b>Rotbaşı</b> Tie Rod End Наконечник рулевой тяги	<b>M12x1,5 Sağ Diş</b> M12x1,5 RHT M12x1,5 Правая Резьба 937 40 722 937 40 622 KBJ047A
17DW1001	<b>Rotbaşı</b> Tie Rod End Наконечник рулевой тяги	<b>M12x1,5 Sağ Diş</b> M12x1,5 RHT M12x1,5 Правая Резьба 937 40 723 937 40 623 KBJ048A
20DW1000	<b>Rotmili</b> Axial Joint Тяга рулевая	<b>M12x1,5 Sağ Diş</b> M12x1,5 RHT M12x1,5 Правая Резьба 96 535 300
26DW2005	<b>Viraj "Z" Rotu</b> Link Stabilizer Тяга стабилизатора	<b>Ön</b> Front Передняя 963 91 875 962 75 798 959 94 977

Asmetal products fit to mentioned trademarks and OE numbers in this catalogue.

SOL / LEFT / ЛЕВАЯ

SAĞ / RIGHT / ПРАВАЯ

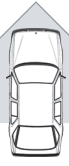

Lacetti 02/2004->

Nubira 07/2003->



17DW2000



17DW2001



26DW2000



26DW0505



26DW0505



26DW2001



10DW2000



10DW2000

**As Metal Ref.**

Kod As Metal

**Açıklama**

Description / Разъяснение

**Orijinal Kod**

Original Number / Оригинальный Код

As Metal Ref. Kod As Metal	Açıklama Description / Разъяснение	Orijinal Kod Original Number / Оригинальный Код
10DW2000	<b>Rotil</b> Ball Joint Шаровая опора	<b>Alt</b> Lower Нижняя
17DW2000	<b>Rotbaşı</b> Tie Rod End Наконечник рулевой тяги	<b>M14x1,5 Sağ Diş</b> M14x1,5 RHT M14x1,5 Правая Резьба
17DW2001	<b>Rotbaşı</b> Tie Rod End Наконечник рулевой тяги	<b>M14x1,5 Sağ Diş</b> M14x1,5 RHT M14x1,5 Правая Резьба
26DW0505	<b>Viraj Rotu</b> Link Stabilizer Тяга стабилизатора	<b>Arka</b> Rear Задняя
26DW2000	<b>Viraj "Z" Rotu</b> Link Stabilizer Тяга стабилизатора	<b>Ön</b> Front Передняя
26DW2001	<b>Viraj "Z" Rotu</b> Link Stabilizer Тяга стабилизатора	<b>Ön</b> Front Передняя

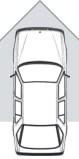

SOL / LEFT / ЛЕВАЯ

SAĞ / RIGHT / ПРАВАЯ

**MATİZ** 09/1998->

**Tico** 02/1995->

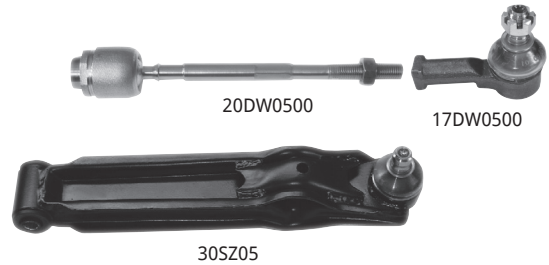
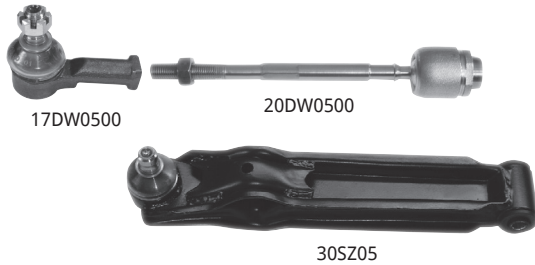

As Metal Ref. Код As Metal	Açıklama Description / Разъяснение	Orijinal Kod Original Number / Оригинальный Код
17DW0500	<b>Rotbaşı</b> Tie Rod End Наконечник рулевой тяги	M12x1,5 Sağ Diş M12x1,5 RHT M12x1,5 Правая Резьба
20DW0500	<b>Rotmili</b> Axial Joint Тяга рулевая	M12x1,5 Sağ Diş Tico İçin M12x1,5 RHT For Tico M12x1,5 Правая Резьба Для Tico
30SZ05	<b>Salıncak</b> Wishbone Рычаг	48810-A78B00 / 4881078BX0 / 521 136 937 410 77 / 937 410 91 KBJ029
		48830-A78B00
		45200 A78B0 0000 96316765

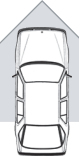

SOL / LEFT / ЛЕВАЯ

SAĞ / RIGHT / ПРАВАЯ

**Nubira** 05/1997->

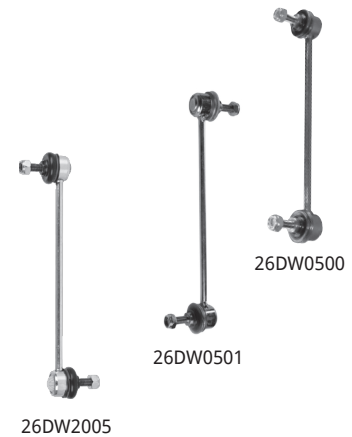

As Metal Ref. Код As Metal	Açıklama Description / Разъяснение	Orijinal Kod Original Number / Оригинальный Код
26DW0500	<b>Viraj Rotu</b> Link Stabilizer Тяга стабилизатора	Arka Rear Задняя
26DW0501	<b>Viraj "Z" Rotu</b> Link Stabilizer Тяга стабилизатора	Ön Front Передняя
26DW2005	<b>Viraj "Z" Rotu</b> Link Stabilizer Тяга стабилизатора	Ön Front Передняя
		963 00 222 963 91 876 963 00 213
		963 00 627
		963 91 875 962 75 798 959 94 977

SOL / LEFT / ЛЕВАЯ
SAĞ / RIGHT / ПРАВАЯ

**FSO Polonez I** 10/1977->12/1991

17FI1000

17FI1010

10FI1010

10FI1000

**FSO Polonez II** 08/1988->08/1992

10FI1000

10FI1010

**FSO Polonez III** 09/1992->

17FI1000

17FI1010

10FI1010

10FI1000

As Metal Ref. Код As Metal	Açıklama Description / Разъяснение	Orijinal Kod Original Number / Оригинальный Код
10FI1000	<b>Rotil</b> Ball Joint Шаровая опора	<b>Üst</b> Upper Верхняя 410 4861 / 414 0985 588 0794 / 588 0298
10FI1010	<b>Rotil</b> Ball Joint Шаровая опора	<b>Alt</b> Lower Нижняя 410 4863 / 588 0795 435 5787 / 567 6985
17FI1000	<b>İç Rotbaşı</b> Inner Tie Rod End Внутренний Наконечник	<b>M16x1 Sol Diş</b> M16x1 LHT M16x1 Левая резьба 410 9626 / 432 7144 434 3760 / 599 5267
17FI1010	<b>Diş Rotbaşı</b> Outer Tie Rod End Внешний наконечник	<b>M16x1 Sağ Diş</b> M16x1 RHT M16x1 Правая Резьба 419 3224 / 432 7142 / 432 7143 410 0024 / 434 3762 / 599 5268

SOL / LEFT / СЛЕВА
SAĞ / RIGHT / ПРАВО

**Rezzo** 09/2000->

26DW2005

26DW2005

As Metal Ref. Код As Metal'a Ref.	Açıklama Description / Разъяснение	Orijinal Kod Original Number / Оригинальный Код
26DW2005	<b>Viraj "Z" Rotu</b> Link Stabilizer Тяга стабилизатора	<b>Ön</b> Front Передняя 963 91 875 962 75 798 959 94 977